

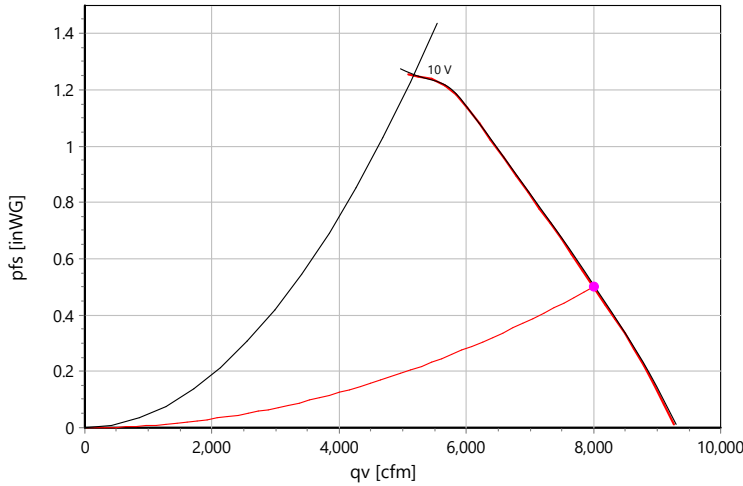

Axial Fan
Type: **AKFG 560 K.6FF A6 Gen3**
Art.-No.: E66-56642



Curve:



p: 1.15 kg/m³; Data @ 230 V

Nominal Data:

U [V]	f [Hz]	Data @ [V]	P _{ed} [kW]	I _N [A]	n _N [r/min]	t _R [°C]	k ₁₀ [m ² /h]	I _A / I _N	IP	m [kg]
3~200-240	50/60	230	2.17	5.7	1780	60	-	-	IP 54	28

Sound Data:

Frequency	Σ	63Hz	125Hz	250Hz	500Hz	1kHz	2kHz	4kHz	8kHz	Distances	1 m	4 m
LwA(A,in) [dB(A)]	86	48	59	71	78	79	81	80	72	LpA(A,in) [dB(A)]	79	69
LwA(A,out) [dB(A)]	87	58	62	74	79	81	81	81	72	LpA(A,out) [dB(A)]	80	70

Wiring Diagram:

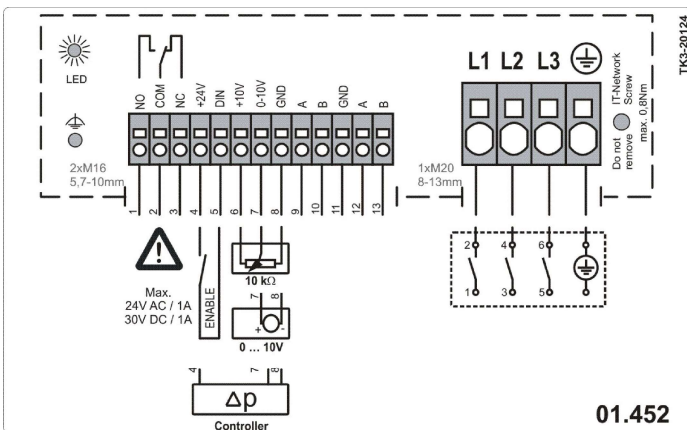

Drawing:

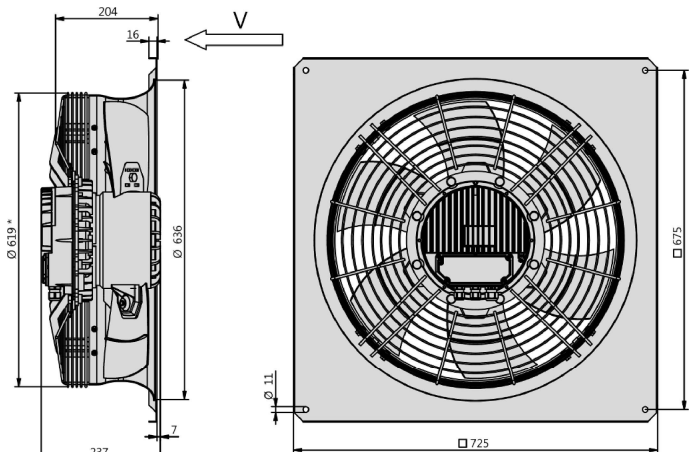

* Maß über Hauptstreben gemessen / dimension measured over main struts

Data @ 208V: 1,97 kW; 5,7 A; 1730 1/min